

# Mist Elimination Liquid-Liquid Coalescing



YOU CAN RELY ON US.

**K KOCH-GLITSCH®**

# Mist Elimination

## Equipment for gas-liquid separations and vapor flow conditioning.

In any process where gas and liquid come into contact, the gas will entrain some amount of the liquid droplets. This entrainment can cause process inefficiencies, product loss, and equipment damage.

## Droplet Formation

The way that droplets are formed determines the size of droplets to be removed. Knowledge of the mechanisms that cause droplet formation and the resulting droplet size is essential to proper mist eliminator selection and design.

Entrainment can be generated by the following mechanisms:

- Mechanical action
- Chemical reaction
- Condensation

The figure below illustrates the typical particle size distribution caused by various mechanisms. Combining this knowledge with experience, the droplet sizes produced can often be estimated with reasonable accuracy.

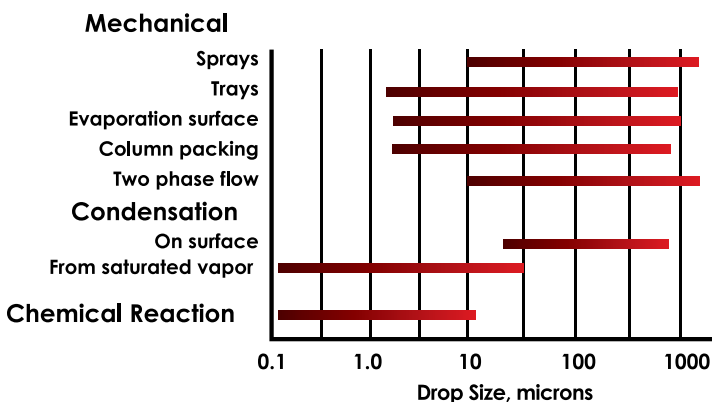

**Mechanical:** Experience shows that droplets generated by mechanical means are commonly 5-10 $\mu$  and larger in diameter. But a boiling or bubbling liquid surface will form droplets down to just a few microns in diameter.

**Chemical Reaction:** When two gases react to form a liquid product, large quantities of submicron droplets are formed, which, in turn, requires high efficiency separation equipment.

**Condensation:** Entrainment swept off the surface of heat exchanger tubes consists mostly of large (50+ microns) droplets. However, extremely fine submicron entrainment is often generated when a liquid condenses directly in the vapor phase due to cooling of a saturated vapor. This type of very fine entrainment can be seen when lubricating oil in a compressor is locally heated and vaporized and then quickly condensed causing a "blue smoke."

## Uses of Mist Eliminators

**Reduce loss of valuable chemicals:** Mist eliminators markedly cut glycol, amine, or solvent consumption in absorption and regeneration towers.

**Increase throughput capacity:** Mist eliminators allow a significant increase in throughput anywhere gases and liquids come into contact in process equipment.

**Improve product purity:** Mist eliminators prevent contamination of side draws and overheads in refinery atmospheric and vacuum towers and other distillation columns.

**Minimize contamination:** Mist eliminators can prevent the poisoning of expensive downstream catalysts or provide boiler feed water quality condensate from evaporator overheads.

**Provide equipment protection:** Mist eliminators protect turbine, blower, and compressor blades, which can eliminate serious maintenance problems.

**Reduce air pollution:** Mist eliminators help diminish droplet emissions to environmentally acceptable levels.

# Common Applications

## Knockout Drums

Designing knockout drums to include mist eliminators will reduce capital equipment costs and improve efficiency. Knockout drums relying solely on gravity settling remove only drops larger than 100 microns. Using an efficient mist eliminator will prevent entrainment of all drops larger than 5 to 10 microns. This higher efficiency reduces product loss; downstream corrosion; contamination; and damage to equipment such as compressors, molecular sieve driers, and blowers. Vessel weights can easily be reduced to half, and handling of liquid slugs is improved.

## Evaporators

Customized mist eliminators reduce carryover of dissolved and undissolved solids to obtain specified steam condensate purity levels below 1 to 50 ppm. This not only prevents product loss, but it also protects compressor internals in vapor recompression systems, provides boiler feed water quality condensate, and prevents potential pollution problems.

Industrial installations vary from chemical plants (caustic and inorganic chemical concentrators), to pulp and paper (black liquor and pulping chemical recovery), to the food industry (sugar, salt, and corn syrup production).

## Steam Drums

Customized mist eliminators reduce carryover of dissolved solids to obtain specified steam condensate purity levels from 1 ppm down to 5 ppb without the need for external separator vessels. Operating pressures can range from 20 to > 2500 psig [1 to 170 bar].

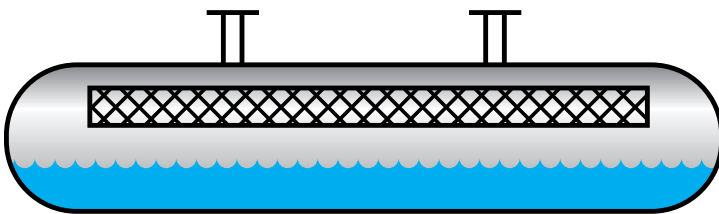

In a typical steam drum, mist eliminators located below the outlet nozzles assure high steam purity.

## Distillation Towers

Liquid entrainment can cause performance problems and limit capacity in packed and trayed distillation towers in two ways.

- At intermediate draw-off trays, entrainment from below reduces product purity and can allow non-volatile contaminants into the draw-off liquid.
- The overhead gas product can also be contaminated with liquid entrainment.

In both cases, the problem is often misinterpreted as a problem with the trays or packing. In reality, it is a problem of entrainment, which can be solved by a properly designed mist eliminator.

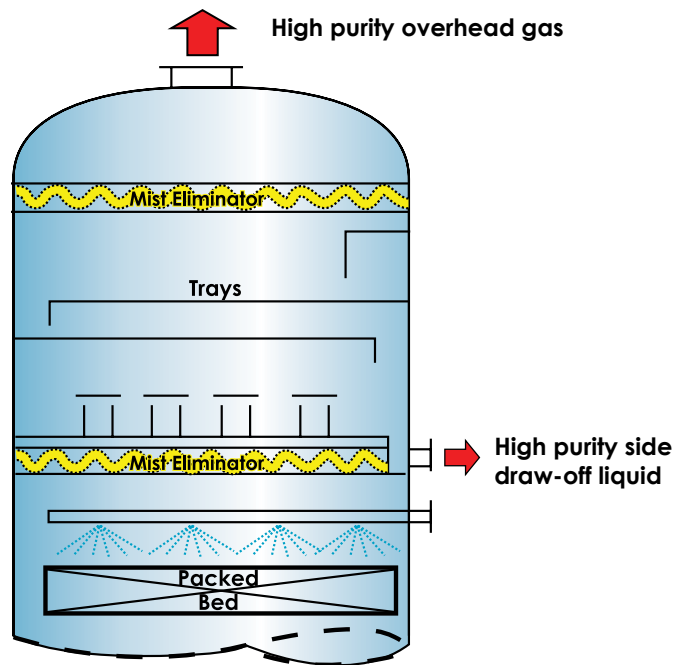

Distillation tower mist eliminators provide high purity overhead gas and liquid draw-off as well as higher tower capacity.

## Scrubbers

From clean gas scrubbers and process vents to fouling services, such as flue gas desulfurization (FGD) systems or steel mill blast furnace exhausts, mist eliminators help improve efficiency and capacity. In severe services, high performance wash systems from Koch-Glitsch are specially engineered to meet the process requirements and considerably extend service life with minimum wash liquid usage.

# Process Applications

## Refineries

Mist eliminators in fractionators increase throughput capacity and allow deeper cuts for greater yields.

- In atmospheric and vacuum pipestills, reduced entrainment from the wash oil zones allows deeper cuts and greater throughput.
- In downstream crackers and reformers, mist eliminators prolong catalyst life by reducing carbon and metals in side draws.



Fractionation tower in major USA refinery.

## Petrochemical Plants

Mist eliminators are used in the interstage knock-out drums of the compressor trains to extend compressor run length and service life. They are also used in quench towers to prevent contamination and protect downstream equipment.

## Flue Gas Desulfurization

High capacity, low pressure drop FLEXICHEVRON® mist eliminators provide excellent resistance to fouling. Utility and industrial scrubbers throughout the world trust the process and mechanical designs offered by Koch-Glitsch.

## Gas Absorption Systems

Designers and operators of gas absorption systems use glycols, amines, and other proprietary solvents to remove water vapor, H<sub>2</sub>S, CO<sub>2</sub>, or other contaminants from gas streams. However, they often follow equipment specifications that have not been optimized to minimize losses of these expensive chemicals. Losses can result from several causes, including the following:

- Carryover losses of absorption chemicals with the treated gas.
- Entrainment losses in the overhead gas from the regeneration towers.
- Foaming resulting from liquid hydrocarbon entrainment into the absorber.

Payback in most systems will be less than one month when upgrading from traditional mesh styles to higher efficiency DEMISTER® mist eliminator styles 822, 822H, or 82.

## Sulfuric Acid Plants

Well-engineered mist eliminators are critical to the cost-effective operation of every sulfuric acid plant. In the drying, intermediate, and final absorption towers, poorly performing mist eliminators contribute to corrosion of ducting, blowers, heat exchangers, and vessels. Stack emissions can result in environmental non-compliance, fines, and potential closure.

Engineers at Koch-Glitsch are very familiar with the special design considerations required for sulfur burning, ore roasting, and sludge burning plants. Koch-Glitsch offers the latest technology in efficiency, safety, service life, and capacity.



Sulfuric acid plant.

# Equipment Selection Guide

**Products are available in a wide range of metals, plastics, thermoplastics, and fiber-reinforced plastics for a wide range of applications, such as absorber towers, scrubbers, knockout drums, evaporators, pollution control, and general mist elimination.**

While the suggestions on this page provide a starting point for the selection of a mist eliminator, your final choice should be made only after reviewing your application with an equipment designer of proven expertise. Koch-Glitsch provides expert resources to help you make the best choice for your particular application.

## DEMISTER® Mist Eliminators

When the vessel size is not set by the mist eliminator, such as is normally the case for distillation towers, steam drums, or evaporators, the practical starting point is often the knitted wire mesh pad type. DEMISTER® knitted mesh mist eliminators provide high separation efficiency at the lowest installed cost.



DEMISTER® style 709 mist eliminator in stainless steel.

## FLEXICHEVRON® Mist Eliminators

When the vessel size is set by the mist eliminator, then the benefits of high capacity FLEXICHEVRON® mist eliminators could be the most cost-effective overall solution.

The fouling resistant FLEXICHEVRON mist eliminator often offers the best solution if the mist contains solid particulates; viscous, sticky liquids; or if large slugs of liquid occur.



FLEXICHEVRON® style VIII mist eliminator in FRP.

## DEMISTER-PLUS Mist Eliminators

In extreme debottlenecking situations or in new designs at very high operating pressures where it is necessary to minimize vessel size and weight, the high capacity characteristics of DEMISTER-PLUS mist eliminators often prove beneficial.

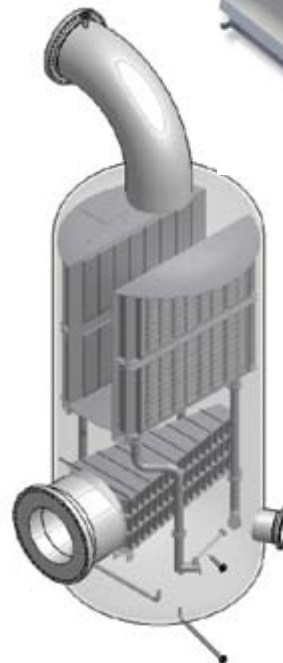

Advanced design DEMISTER-PLUS two-stage mist eliminator.

## FLEXIFIBER® Mist Eliminators

FLEXIFIBER® mist eliminators are the only type that can effectively remove submicron size particles.



FLEXIFIBER® type IC-SRF mist eliminator.

	DEMISTER® mist eliminator	FLEXICHEVRON® mist eliminator	DEMISTER-PLUS mist eliminator	FLEXIFIBER® mist eliminator
100% Efficiency	3-10µ	10-40µ	7-10µ	<0.1µ
Pressure Drop wc	< 1in [25 mm]	0.4-3.5 in [10-89 mm]	1-20 in [25-508 mm]	2-20 in [51-508 mm]
Gas Capacity	3	2	1	4
Liquid Capacity	3	1	2	4
Solids Handling	3	1	2	4
Cost	1	2	3	4

# DEMISTER® Mist Eliminators

## High collection efficiency and low pressure drop.

The DEMISTER® mist eliminator is an assembly of YORKMESH knitted mesh that is supported with high open area grids.

DEMISTER mist eliminators are made to any size and shape from a wide range of materials, both metal and non-metal. Stainless steels and exotic alloys are fully annealed to provide maximum corrosion resistance.

Based on years of actual in-plant performance, Koch-Glitsch engineers use special families of mesh styles for particular equipment and processes to meet customer efficiency requirements.



## How a DEMISTER® Mist Eliminator Works

1. A vapor stream carrying entrained liquid droplets passes through a DEMISTER pad. The vapor moves freely through the knitted mesh.
2. The inertia of the droplets causes them to contact the wire surfaces and coalesce.
3. The large, coalesced droplets formed in the mesh ultimately drain and drop to the vessel bottom.

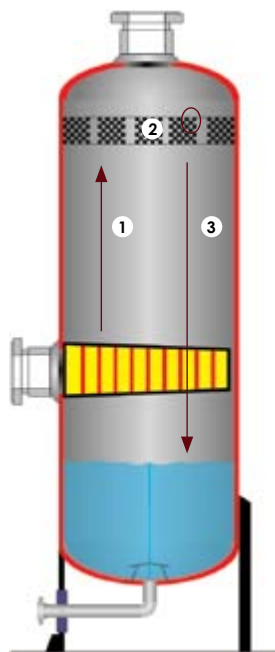

## Characteristics of DEMISTER® Mist Eliminators

- Easy to install in all process equipment
- Most cost-effective solution when equipment sizes are set by other requirements
- High efficiency with low pressure drop
- Emergency delivery available

## Materials of Construction

- Stainless steel
- Nickel-based alloys
- Titanium
- Aluminum
- Copper
- Polypropylene
- Fluoroplastics
- Other special materials available on request. For example, Alloy 66 and SX® are specially designed materials used to extend service life in sulfuric acid plants.

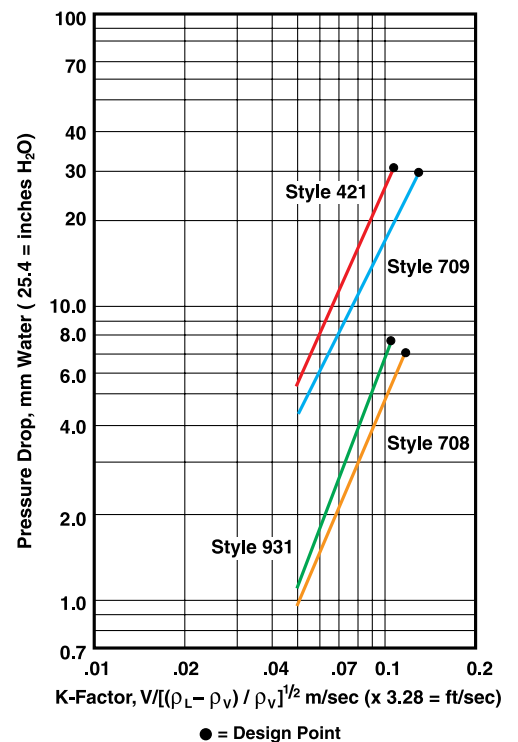

Comparative pressure drop of several DEMISTER® mist eliminators in air-water system at atmospheric conditions.

## Design Parameters

For general design, Equation 1 has been used as a velocity guideline for many years.

### Equation 1

$$V = K [(\rho_L - \rho_V) / \rho_V]^{1/2}$$

Table 2. Units for Equation 1		
	English	Metric
V - design velocity	ft/sec	m/sec
$\rho_L$ - liquid density	lb/ft <sup>3</sup>	Kg/m <sup>3</sup>
$\rho_V$ - vapor density	lb/ft <sup>3</sup>	Kg/m <sup>3</sup>
K - capacity factor	ft/sec	m/sec

The recommended design value of “K” varies depending on several system factors, which include liquid viscosity, surface tension, entrainment loading, and the content of dissolved and suspended solids. Recommended “K” values are also highly dependent on the mesh structure and vessel geometry.

Over 60 years ago, Koch-Glitsch developed the traditional mist eliminator styles that became the worldwide standards in the chemical process industries. The industry adopted a standard guideline,  $K = 0.35$  ft/sec [0.107 m/sec] for calculations based on these traditional KOCH-OTTO YORK® styles. Improved high capacity styles have been developed. This development continues today.

Excellent performance is often obtained from 30-110% of the calculated design value. Operating pressure drop is usually negligible, < 1 in. [25 mm] wc. For high vacuum applications, high performance is routinely achieved with  $\Delta P$  on the order of 0.1 in. [2-3 mm] wc.

## High Capacity DEMISTER® Mist Eliminators

Koch-Glitsch has developed and refined a new family of DEMISTER mist eliminators that replace traditional knitted mesh styles.

The new high capacity styles take advantage of improved knowledge about the way internal wire geometry affects capacity and performance in the same way that structured packing surpassed random packing performance in distillation columns.

Compared to the older styles, the high capacity DEMISTER styles from Koch-Glitsch can provide:

- 20% or more design capacity.
- Lower pressure drop.
- Higher efficiency at design velocity.
- Equal or better corrosion and fouling resistance.

Traditional Style	High Capacity	Capacity Gain	Efficiency Gain	Description
371	215	>35%	Same	Glass fiber & metal for maximum efficiency
326	194	>25%	Same	Ultra-efficiency design for fine particles
421	709	>20%	Same	Heavy duty, high efficiency design
431	172	>20%	Same	General purpose style
931	708	>22%	Same	High open area for viscous or dirty liquid

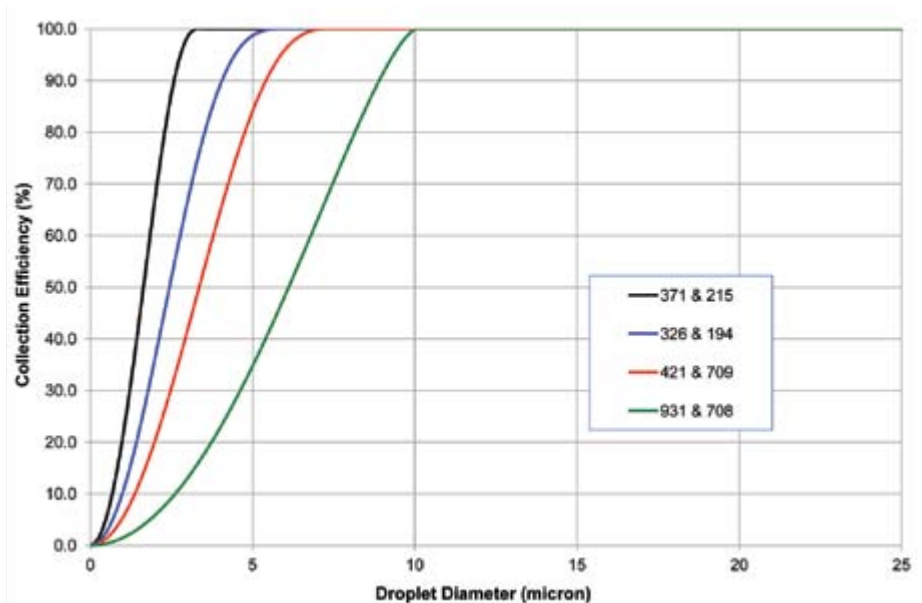

Comparative efficiencies of various DEMISTER® mist eliminator styles in air-water system at atmospheric conditions.

# FLEXICHEVRON® Mist Eliminators

## Lowest pressure drop and high liquid loads.

FLEXICHEVRON® mist eliminators are baffle or zigzag blade modules tailored for either vertical or horizontal flow installations.

Depending on design parameters and operating conditions, these mist eliminators collect essentially 100% of all particles greater than 8 to 40 microns in diameter.

Manufactured in virtually any size from a wide range of metal alloys, thermal-set plastics, and fiber-reinforced plastic (FRP), over 20 different styles can be designed and fabricated.

Applications for which FLEXICHEVRON mist eliminators are ideal include:

- Scrubbers in utility flue gas desulfurization (FGD) systems
- Phosphoric and sulfuric acid plants
- Crude oil refinery vacuum towers
- Pulp mill, sugar refinery, and chemical plant evaporators
- Upstream gas processing
- LNG plants

## Characteristics of FLEXICHEVRON® Mist Eliminators

- Ideal for applications where solids or viscous, sticky liquids rapidly plug a wire mesh type mist eliminator
- Vertical (upward) or horizontal flow designs
- Lowest pressure drop of any type mist eliminator
- Able to handle high liquid loads
- Good turndown

## Materials of Construction

- Stainless steel
- Carbon steel
- Nickel-based alloys
- Titanium
- Fluoroplastics
- Polypropylene
- Polysulfone
- Other special materials available on request





## Design Parameters

The reentrainment point is a function of gas velocity, as well as other physical properties, e.g., vapor density, liquid density, and liquid surface tension.

The reentrainment point is also highly sensitive to the geometry of the chevron. A chevron with superior liquid draining capability and optimum chevron blade spacing can be operated at a higher reentrainment point, yielding a higher capacity.

The difference between droplet penetration and reentrainment is often confused. Droplets that penetrate the chevron are too small to be effectively removed by impaction. On the other hand, reentrained droplets are generally quite large and originate from droplets that have coalesced on the chevron blades. At high gas velocities, a chevron can have a removal efficiency of 100% and, simultaneously, reentrain extensively. Conversely, at low gas velocities, the chevron may not reentrain but has insufficient removal. Optimal chevron performance is achieved at a gas velocity that is as high as possible but not so high that it yields reentrainment.



**FLEXICHEVRON® style XII/XIV mist eliminators are designed for high capacity FGD applications.**

## Optimal Design for Conventional FLEXICHEVRON® Mist Eliminators

In arriving at an optimal design, it is often necessary to make a compromise between removal efficiency on the one hand and pressure drop and plugging tendency on the other.

To do so, it is necessary to have some knowledge of the droplet-size distribution entering the mist eliminator. While exact inlet droplet-size distributions are seldom known, experienced Koch-Glitsch designers are familiar with most mist elimination applications and can help with understanding the solutions available. Koch-Glitsch has established proprietary know-how through application of extensive air-water testing, computational fluid dynamic (CFD) simulation, and commercial data confirmations.

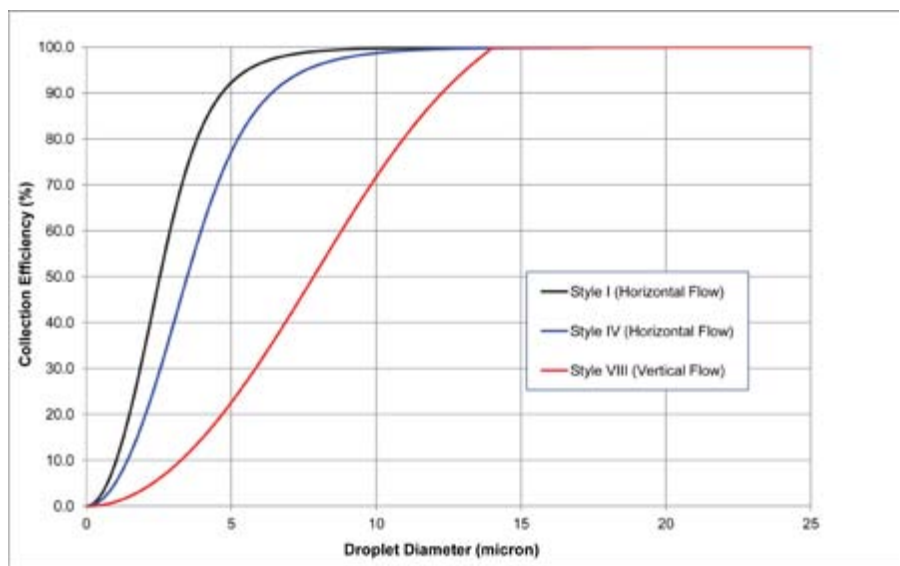

**Typical collection efficiency vs. droplet size of a FLEXICHEVRON® mist eliminator in air-water system at atmospheric conditions.**

## Applications

FLEXICHEVRON mist eliminators should be used any time that plugging of wire mesh mist eliminators is a risk. These applications include:

- Air pollution control scrubbers where dissolved or undissolved solids can be present.
- Applications where droplets will be sticky or viscous and will plug classic knitted wire mesh mist eliminators.
- High vacuum applications, such as evaporators and vacuum crude units, where minimum pressure drop is critical.

# High Capacity FLEXICHEVRON® Mist Eliminators

## Special designs for higher pressure systems.

The higher capacity FLEXICHEVRON® style 250 and 350 mist eliminators rely primarily on separate liquid drainage channels for their high capacity. These designs offer higher allowable velocities and different vane geometries. This results in more efficient mist removal, especially at higher pressures where the allowable velocity decreases with the increasing gas density.

The unique characteristic of the style 250 or 350 designs is their “double pocket” construction. Strategically located slots allow coalesced liquid on the blade surfaces to be collected and directed into internal channels shielded from the gas flow. Once inside these channels, the collected liquid is then directed to drains that lead to a liquid sump in the bottom of the vessel or a seal system (cup). Compared to the unshielded single pocket designs, they also provide higher turndown before noticeable efficiency losses are experienced.



FLEXICHEVRON® style 250 high capacity mist eliminator for horizontal gas flow.

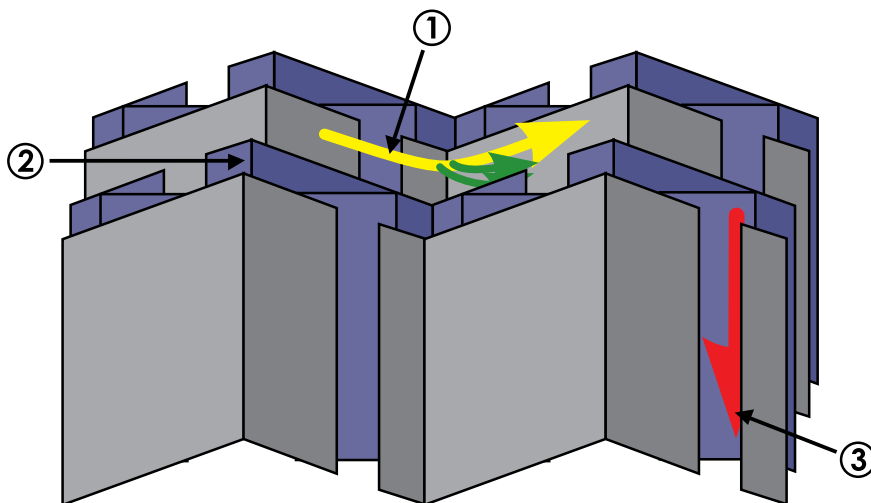

Horizontal gas flow.

## Characteristics of High Capacity FLEXICHEVRON® Mist Eliminators

- Custom engineered to fit any vessel shape
- Allow reduced vessel sizes and weights
- Sturdy, durable construction
- Maintain efficiency at higher pressures

## Materials of Construction

- Stainless steel
- Carbon steel
- Nickel-based alloys
- Titanium
- Other special materials available on request

## How a High Capacity FLEXICHEVRON® Mist Eliminator Works

1. Double pocket hooks direct the collected liquid (green arrow) away from the main gas stream (yellow arrow).
2. The collected liquid (green arrow) flows into separate channels (purple).
3. The separate channels move the liquid away from the gas (red arrow).

Because the liquid is now isolated from the gas stream and less subject to reentrainment, gas velocities can be more than doubled in both horizontal and vertical gas flow configurations.

## Performance of High Capacity FLEXICHEVRON® Mist Eliminators in Air/Water System

Using double pocket FLEXICHEVRON mist eliminators, it is possible to efficiently remove droplets smaller than 10 microns in diameter in clean service even at higher pressures.

The table and graph below show the capacity and pressure drop performance of typical designs in an air/water system. Droplet size separation efficiency will be affected by physical properties of the gas and liquid phases, gas velocity, liquid and gas densities, and liquid surface tension.



FLEXICHEVRON® style 350 high capacity mist eliminator for vertical gas flow.

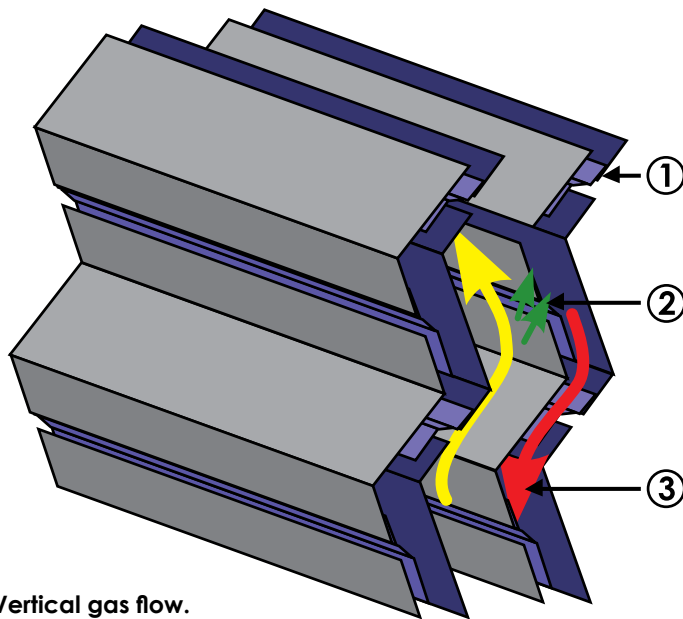

Vertical gas flow.

## General Design Parameters

As with other types of mist eliminators, selection of the proper mist eliminator is affected by:

- Gas and liquid properties
- Pressure
- Quantity of entrainment and solids
- Desired performance

To make a preliminary selection:

1. Determine actual velocity by using Equation 1 (as described on page 7).
2. Choose K values based on table below. The table shows capacity and turndown ratios achievable with reasonable efficiency for high capacity designs.

Vane Type	Operating K Value ft/s (m/s) (through vane)	
	Minimum	Maximum
Style 250: Horizontal Flow High Capacity	0.12 [0.04]	1.15 [0.35]
Style 350: Vertical Up Flow High Capacity	0.12 [0.04]	1.15 [0.35]

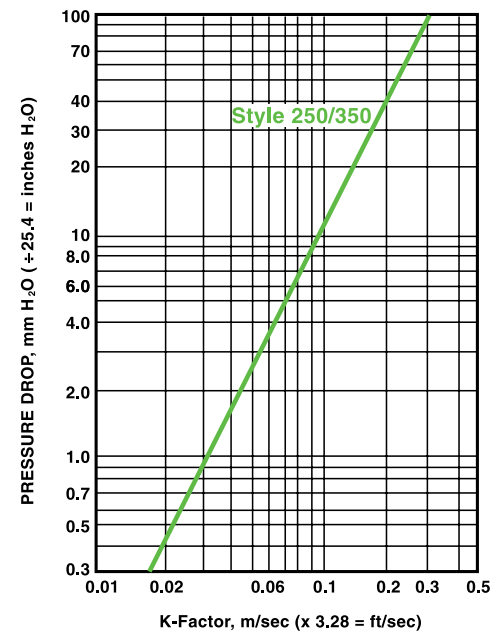

Comparative pressure drop in air-water system at atmospheric conditions.

# DEMISTER-PLUS Mist Eliminators

## Reduce new vessel size or increase capacity in existing vessel.

The DEMISTER-PLUS mist eliminator is an advanced engineering design that is often used to minimize the size of new vessels or increase capacity in existing vessels.

## Designing for More Capacity

In most process installations, vessel size is determined by needs other than mist eliminator capacity, such as:

- Capacity of trays or packing
- Evaporator volume requirements
- Liquid holdup requirements

In these cases, traditional mist eliminator designs will readily meet the capacity. In some equipment, particularly in knockout drums, the vessel size is set by the requirements of the mist eliminator itself. When plants are revamped for additional capacity, it is almost always more economical to reuse existing vessels rather than replace them with larger equipment.

## High Capacity, Two-Stage Mist Eliminator

The advanced design DEMISTER-PLUS mist eliminator can achieve even greater increases in capacity over the high capacity DEMISTER mist eliminator. The well-proven DEMISTER-PLUS design features a two-stage mist eliminator, combining the efficiency of the DEMISTER mist eliminator with the high throughput capacity of the FLEXICHEVRON mist eliminator.

- In new plant construction, these designs reduce knockout drum investment substantially while maintaining separation efficiency. Vessel diameter can usually be reduced by 25 to 40% and, because the shell thickness is a function of diameter, vessel weight can be reduced by 50 to 75%.
- In revamp situations, more than 300% capacity gain can be achieved, depending on the existing vessel geometry.
- When needed, revamp modifications can be accomplished without welding.

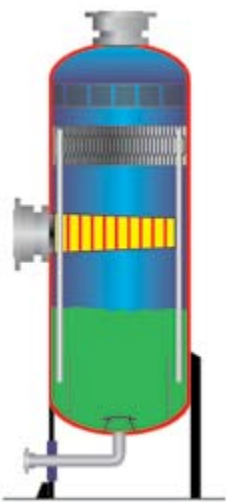

Vertical flow DEMISTER-PLUS type VM-V mist eliminator combines the high liquid handling capacity of a FLEXICHEVRON® mist eliminator with the high efficiency of a DEMISTER® mist eliminator.

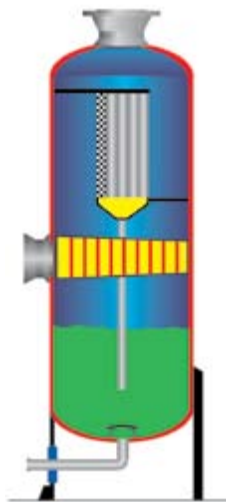

Horizontal flow DEMISTER-PLUS type MV-H mist eliminator designs allow substantial increases in throughput capacity in any knockout or flash drum.

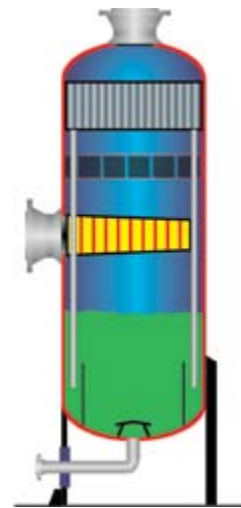

Vertical flow DEMISTER-PLUS type MV-V mist eliminators use high capacity FLEXICHEVRON® mist eliminators for higher efficiency at increased capacity.

# Separator Optimization

Equipment for improving flow distribution in gas-liquid and liquid-liquid separation vessels.

## Uniform Feed Distribution

Inlet nozzles are a common problem area in retrofitting situations because under-designed inlet distributors allow localized high velocities, which create severe liquid entrainment. The high gas flow volumes at the inlet nozzle create poor gas distribution in crowded drums or distillation towers.

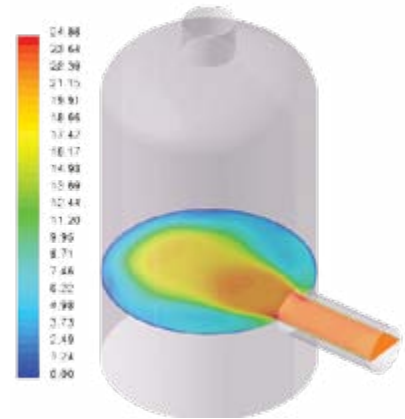

Localized velocity patterns with a plain nozzle inlet.

## YORK-EVENFLOW Vane Inlet Device

The YORK-EVENFLOW vane inlet device decreases the momentum of the inlet feed stream in a controlled manner, which allows:

- Removal of bulk liquid and solids.
- Even distribution of the gas flow over the downstream mist elimination devices.
- Minimization of droplet shatter, which prevents creation of additional fine entrainment.
- Reduction of gas velocities flowing over the liquid surface below the feed point, which prevents reentrainment of previously collected liquid caused by shear on the liquid surface.

### Characteristics of YORK-EVENFLOW Vane Inlet Device

- Evenly distributes the vapor to reduce channeling
- Gradually reduces high inlet momentum
- Diverts high liquid loads away from the mist eliminator
- Prevents reentrainment of liquid droplets from the surface below the feed point
- Modular construction allows installation through vessel manways
- Custom engineered for vertical or horizontal vessels

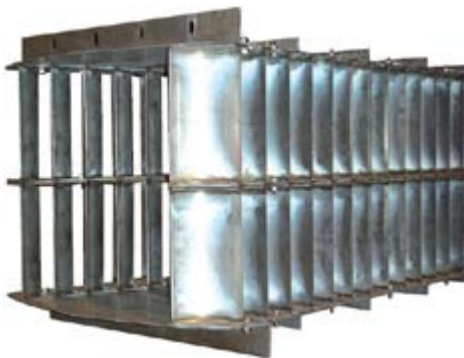

View of YORK-EVENFLOW vane inlet device. Design and performance are superior to traditional baffles or dished splash plates.

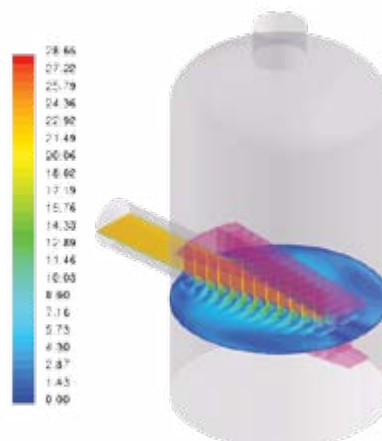

Localized velocity patterns with the YORK-EVENFLOW vane inlet device.

# Computational Fluid Dynamics Modeling

**A reliable tool for design optimization, troubleshooting, and product development.**

Flow distribution is critical in all gas-liquid and liquid-liquid separation vessels. As vessel sizes are reduced or more capacity is expected from existing equipment, traditional design rules for vessel geometry and flow distribution must be reviewed for all elements that can affect separation performance, such as:

- Flow velocities through inlet and outlet nozzles
- Spacing between nozzles
- Internals
- Liquid levels

CFD modeling is used by engineers at Koch-Glitsch to simulate flow conditions and vessel geometry. The modeling provides a close approximation of the fluid flow profile inside the vessel.

- For existing installations, poor flow distribution can be identified as the cause of unexpected high liquid carryover.
- In retrofit situations where the process conditions may be increasing, design modifications can be evaluated and optimized with high assurance that the desired performance will be achieved.
- For new equipment, optimized CFD designs result in size and weight reductions that provide savings beyond the lower cost of the separator. In addition to reduced vessel cost, there are usually associated savings in foundations and support structures.

The case illustrated below was a study of the velocity patterns inside a critical separator vessel operating under vacuum. For optimal performance, it was important that the velocity profile through the mist eliminator be uniform. The CFD study confirmed this to be the case.

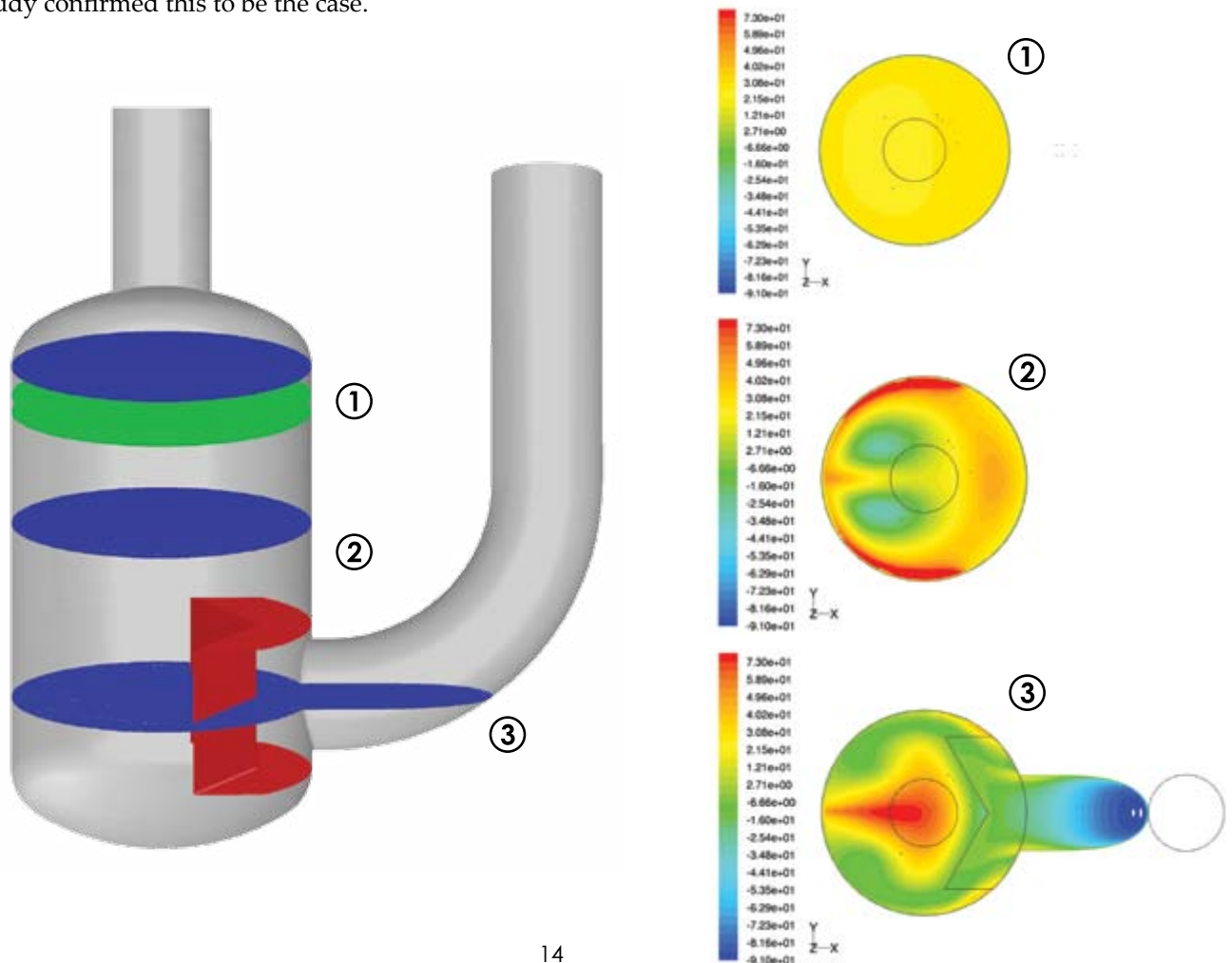

# FLEXIFIBER® Mist Eliminators

## Reduce visible stack gas plumes and provide unlimited turndown

The custom designed and fabricated FLEXIFIBER® mist eliminators consist of a special media contained between either two concentric screens or two flat parallel screens.

Depending upon design parameters, FLEXIFIBER mist eliminators can achieve high separation efficiency of all submicron liquid particles.



This mist eliminator is ideal for use in the following applications:

- Sulfuric, nitric, and thermal phosphoric acid plants
- Chlorine and other chemical plants
- Pulp mills
- Textile mills
- Asphalt saturators
- Food processing operations
- Chrome plating processes
- Turbine lube oil tank vents
- Plastic forming operations

## How a FLEXIFIBER® Mist Eliminator Works

1. Mist-laden gases enter the vessel and pass horizontally through the fiberbed.
2. Separated liquids drain downward on the inside surface of the element.
3. Liquids pass through the drain leg and are collected at the bottom of the vessel.
4. Clean gases exit at the top of the vessel.

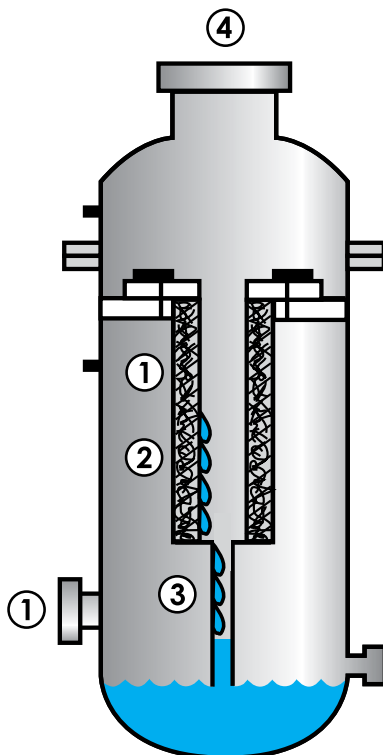

## Characteristics of FLEXIFIBER® Mist Eliminators

- Reduce or eliminate visible stack gas plumes
- Provide unlimited turndown from design capacity for type BD elements
- Can be designed for very low pressure drop
- Interchange with existing fiberbed equipment

## Materials of Construction

### Cages

- Wide variety of metal alloys
- Thermal-set plastics and plastics
- FRP

### Packed Fiberbeds

- Special glass
- PTFE
- Polyester fiber
- Special carbon fiber media is available for those applications that contain fluorides, high pH, or steam.

## Separation Mechanisms

Koch-Glitsch offers three types of FLEXIFIBER mist eliminators that operate based on separation mechanisms as shown below.

### Inertial Impaction

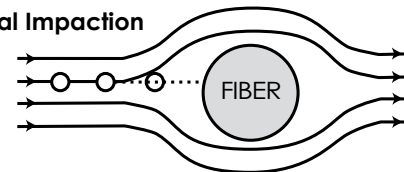

### Direct Interception

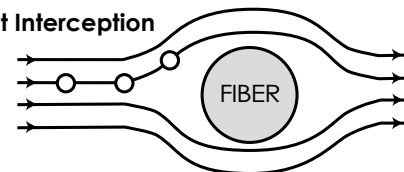

### Brownian Diffusion

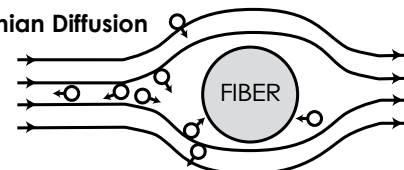

Mechanisms for mist collection on fibers.

## FLEXIFIBER® Type BD (Brownian Diffusion) and Type BD-LdP (Low Pressure Drop) Mist Eliminators

Type BD elements are normally cylindrical in shape and are available in a wide variety of materials.

Using the Brownian Diffusion mechanism, the type BD element is able to achieve collection efficiencies of up to 100% on all submicron liquid particles even below 0.1 microns. Operating pressure drops are normally designed in the range of 2-20 in. [50-500 mm] wc.

An interesting feature of the FLEXIFIBER type BD mist eliminator is that, with submicron particles, the collection efficiency slightly increases as the gas flow rate through the bed is reduced. This is due to the liquid droplets having a longer residence time in the fiberbed, which provides an increased chance for the liquid particles to contact individual fibers and be collected.

FLEXIFIBER type BD-LdP fiberbed is a new product developed by Koch-Glitsch that increases the collection efficiency of submicron particles while reducing pressure drop (when compared to conventional fiberbed technology). Where fiberbeds are large consumers of energy, such as the case in chlorine and sulfuric acid production trains, this results in significant reductions in operating costs. In addition to the specific processes cited above, this technology can bring benefits to any process in the form of decreased investment and operating costs, as well as improved plant performance.

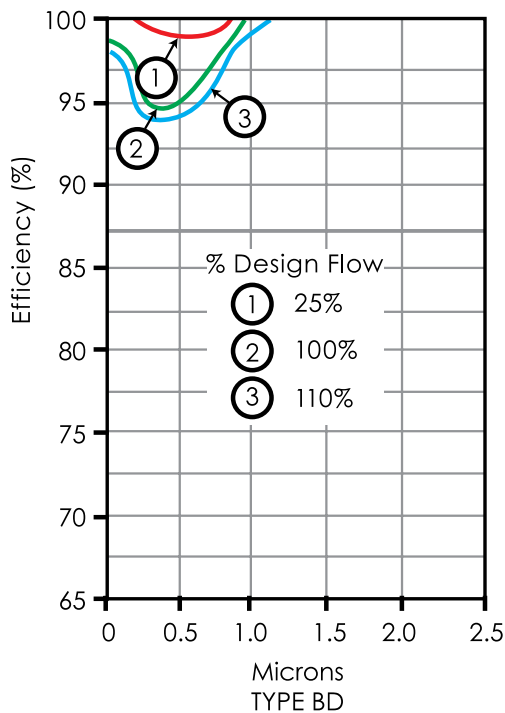

Typical performance curves for FLEXIFIBER® mist eliminator type BD in air-DOP system at atmospheric conditions.

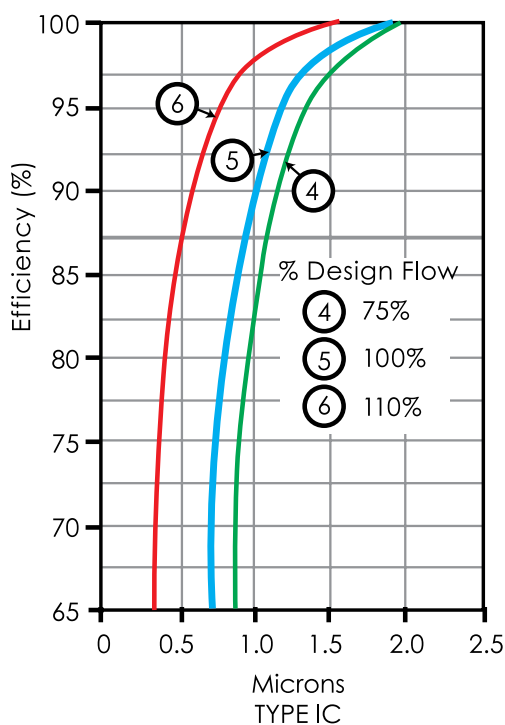

Typical performance curves for FLEXIFIBER® mist eliminator type IC in air-DOP system at atmospheric conditions.

## FLEXIFIBER® Type IC (Impaction Cylinder) Mist Eliminators

Primarily by using the impaction mechanism, type IC fiberbeds are designed to capture liquid particles 1 micron and larger. Collection efficiencies on 1 micron particles will vary from 90% on liquid mists with a specific gravity of 1.0 to 97% on liquid mists with a specific gravity of 1.8. Operating pressure drops are usually in the range of 4-10 in. [100-250 mm] wc.

### FLEXIFIBER® Type IC-M, IC-K, and IC-KLF Mist Eliminators

FLEXIFIBER type IC-M and IC-K fiberbeds are specially designed to meet the needs of today's sulfuric acid plants. FLEXIFIBER type IC-M is an alternative to type BD in both the drying and absorption towers, offering a combination of both high capacity and efficiency. FLEXIFIBER type IC-K and our newly introduced type IC-KLF combine our knitted wire mesh and fiberbed technologies to produce extended life mist eliminators that are less inclined to foul with solids. This results in both energy savings as well as longer run lengths in critical services such as sulfuric acid drying towers.



# Liquid-liquid Coalescing

**Reduce size of new vessels, increase capacity of existing drums, and improve product purity.**

When gravity forces alone do not produce an efficient separation of immiscible fluids, adding a Koch-Glitsch liquid-liquid coalescer system can improve separation efficiency. High separation efficiency can result in only a few parts per million (ppm) liquid dispersion in the liquid effluent stream.

## Why Liquid-liquid Dispersions Occur

Mixtures of two immiscible liquids occur throughout the process industries. Often this is an unavoidable result of the process. In other cases, the mixing of two liquids is necessary to obtain mass transfer between the phases or to promote a chemical reaction. Usually, a full separation of the liquids will be important for efficient and cost effective performance of the downstream process. The size of the resulting droplets (dispersed phase) and the ease of their separation from the continuous phase are partially dependent on how the dispersion is created, as shown in the chart below.

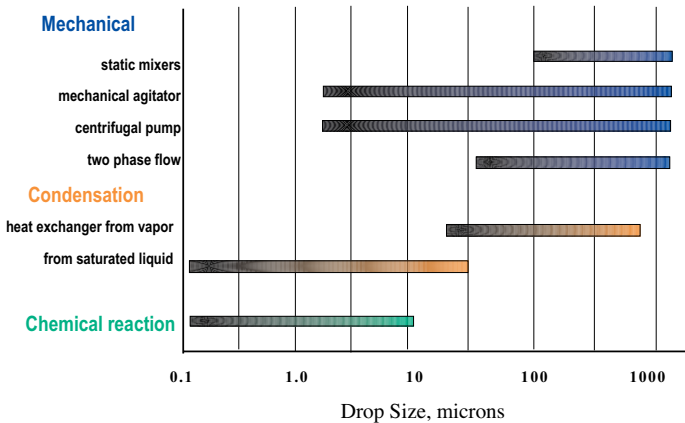

Equally important are the physical properties of the two liquids, including interfacial tension, density difference and viscosity. The presence of solids and trace impurities, as well as pH and temperature changes can completely alter the characteristics and ease of separation. For example, it is quite possible for even a small presence of impurities to change an easy separation into a difficult emulsion.

Because of this complexity, a theoretical calculation describing the separation of two liquids can only be done based on assumptions of pure liquids, which never occurs in the real world. Therefore, the selection and design of liquid separation equipment is based on a combination of basic principles, experience, and trial testing.

## Design of Coalescer Vessels

Many separators consist merely of a horizontal vessel, as shown in the diagram below, where the separation occurs by allowing the droplets to settle by gravity.

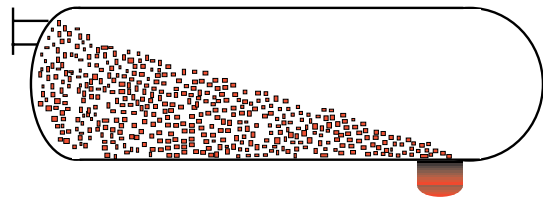

Droplets rise (when they are the lighter phase liquid) or fall (when they are the heavier phase) based on the following equation, which is derived from Stoke's Law.

$$V = g (\rho_H - \rho_L) D^2 / 18\mu$$

where:

- V = Settling velocity (cm/sec)
- g = Gravitational constant (98/cm/sec<sup>2</sup>)
- μ = Viscosity of continuous phase (poise)
- ρ<sub>H</sub> = Density of heavy liquid (g/cm<sup>3</sup>)
- ρ<sub>L</sub> = Density of liquid liquid (g/cm<sup>3</sup>)
- D = Droplet diameter (cm)

For a water droplet falling in an oil with a density of 50 lb/cu ft [800 Kg/m<sup>3</sup>], the settling rates are shown in the graph below.

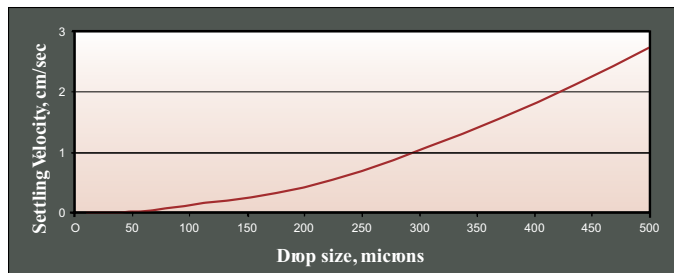

## Droplet Settling Velocity

These traditional separators are not economical because they require long residence times to achieve separation of even 150-200 micron droplets. They are rarely justified in new designs unless large surge capacity is required for process reasons, or because of very heavy solids loadings or high viscosity liquids in the process.

## Coalescer Options

---

### Improving the process.

Droplet settling is strongly affected by both the droplet size and the distance the droplet must settle before it reaches the interface between the two liquid phases. Both of these factors can be influenced through the selection of internals to accelerate the separation.

### Parallel Plate Separators

While droplets larger than 200-300 microns diameter will settle quickly, smaller droplet dispersions require excessive settling times when they must travel long distances to the interface. With the use of parallel plates, the designer can create many interfaces within the same vessel, which allows significant reductions in separate vessel sizes.

For dispersions down to 40-100 microns, it is possible to achieve efficient separation with this technique, and it is the preferred equipment design where the potential for solids or tarry liquids exists.



### KY-FLEX® Liquid-liquid Coalescing Media

These corrugated plate separators are an improvement over the parallel plate separators except where severe solids loadings require the extra large spaces that the parallel plates allow. Properly structured, the corrugations provide superior collection and drainage channels for liquids and solids. A variety of corrugation geometries and spacings are available to optimize the fouling resistance and efficiency to the needs of each process.



### KY-MESH Liquid-liquid Coalescing Media

Another approach focuses on increasing the size of droplets by coalescing them into easily separated drops larger than 200 microns so they will quickly separate by gravitational force. Generally, this technique is aimed at the smaller droplets, from 100 microns down to a few microns diameter, which settle very slowly or not at all. Often referred to as secondary dispersions, haze, or emulsions, these applications present the biggest challenge and are solved with high performance coalescing media engineered for the properties of the specific chemicals involved. This media consists of mixtures of metal and non-metallic wires and fibers. The internal geometry promotes droplet size growth and maximizes liquid throughput velocities for minimum vessel sizes.



## Coalescer Designs for Common Applications

Created using combinations of KY-MESH and KY-FLEX® liquid-liquid coalescing media and parallel plate separators, the exact combination of products in each coalescer system varies depending on the application. With over 50 years experience providing coalescers, Koch-Glitsch engineers have the knowledge and experience to select an effective solution to meet specific application requirements. The coalescers pictured below are representative of the designs provided by Koch-Glitsch for common applications. Each system will vary based on specific process requirements.

### Hazy Distillates

As product cools in storage tanks, dissolved water comes out of solution to form water droplets. These water droplets, which make up a small percentage of the feed, create a haze that results in off-specification product. Without proper coalescing media, use of the product is delayed until the water settles out by gravitational forces alone.

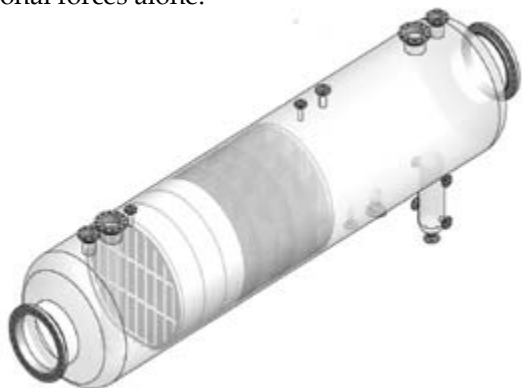

Isometric view of two-phase horizontal coalescer/settler.

### Refinery Fractionator Overhead Reflux Drum

These drums frequently become a bottleneck when the towers they service are fitted with higher capacity internals. The higher throughput rates in the modified tower increase separation demands on the overhead drum. Poor liquid-liquid separation in the drum creates high water level in the reflux stream that can lead to corrosion on the trays and increased energy consumption in the tower.

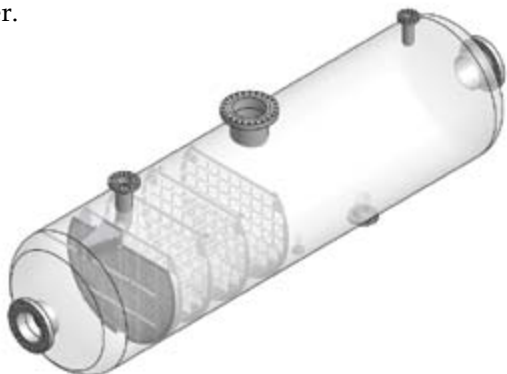

Isometric view of three-phase horizontal coalescer/settler.

### Alkylation Units

In refineries, there are several steps where sulfuric acid, caustic, or water mix with hydrocarbon streams and then are separated. It is critical that these separations are as sharp and clean as practical to minimize acid and caustic consumption as well as to minimize the potential for fouling/corrosion in downstream equipment.

### Wastewater Treatment Facilities

Upsets in the main production plant can often burden the water effluent treatment facilities with increased hydrocarbon removal requirements before water discharge.

### Three-phase Horizontal Coalescer/Settler

In the HPI, the three-phase horizontal coalescer/settler is a common separator type applied in the overhead systems of distillation columns or as an upstream separator associated with oil and gas production. As the name implies, this vessel separates three phases: gas, light-phase liquid and heavy-phase liquid (usually water).



Isometric view of three-phase vertical coalescer/settler.

# Koch-Glitsch Corporate Offices

## Worldwide Headquarters

### Koch-Glitsch, LP

4111 East 37th Street North

Wichita, KS 67220 - United States

tel: (316) 828-5110

fax: (316) 828-7985

## Europe

### Koch-Glitsch Italia S.r.l.

Via Torri Bianche, 3A

20871 Vimercate MB - Italy

tel: +39-039-6386010

fax: +39-039-6386011

### Koch-Glitsch BVBA (KOCH-OTTO YORK® Separations Technology)

Bijkhoevelaan 26

B-2110 Wijinegem - Belgium

tel: +32-3-647-28-47

fax: +32-3-647-28-79

## Asia

### Koch Chemical Technology Group Singapore Pte. Ltd.

260 Orchard Road, #11-01/09  
The Heeren

Singapore 238855

tel: +65-6831-6500

fax: +65-6835-2031

### Koch-Glitsch (a division of Koch Chemical Technology Group India Pvt. Ltd.)

10th Floor, Corporate Park II  
Sion-Trombay Road

Chembur, Mumbai 400 071 - India

tel: +91-22-6771-7171

fax: +91-22-6771-7161

For a complete list of our offices and facilities, visit us on the Web at [www.koch-glitsch.com](http://www.koch-glitsch.com).



## Emergency Numbers

**United States/Latin America:** 1-888-KOCH-911 (mass transfer), 1-316-207-7935 (mist elimination),  
or your local Koch-Glitsch office.

**Canada:** 1-905-852-3381 (Uxbridge, Ontario).

**Europe/Middle East/Africa:** +39-06-928-911 (Italy), +44-1782-744561 (United Kingdom),  
or your local Koch-Glitsch office.

**Asia:** +65-6831-6500 (Singapore) or your local Koch-Glitsch office.

### Trademarks

The following registered trademarks are owned by Koch-Glitsch, LP in the United States and may be registered in other jurisdictions: DEMISTER® mist eliminator, FLEXICHEVRON® mist eliminator, FLEXIFIBER® mist eliminator, KY-FLEX® liquid-liquid coalescing media, KOCH-GLITSCH® technology, "K" KOCH-GLITSCH (logo), KOCH-OTTO YORK® separations technology, and OTTO YORK and design (football). The following trademarks are owned by Koch-Glitsch, LP in the United States and may be registered in other jurisdictions: DEMISTER-PLUS mist eliminator, KY-MESH liquid-liquid coalescing media, YORK-EVENFLOW vane inlet device, YORKMESH knitted wire mesh and YOU CAN RELY ON US. All other trademarks, service marks, or registered trademarks that appear in this document are the trademarks or service marks of their respective owners.

For related trademark information, visit <http://www.koch-glitsch.com/trademarks>.

### Legal Notice

The information contained in this bulletin is believed to be accurate and reliable, but is not to be construed as implying any warranty or guarantee of performance.